



Sistema Titanium

Abatibles y fijos

Window World



**CATALOGO GENERAL DEL SISTEMA
ABATIBLE TITANIUM**

ÍNDICE

Generalidades.....	2
Configuraciones posibles.....	2
Secciones de perfiles.....	3
Ensamble:	
Sistema puerta abatible.....	6
Sistema puerta abatible + fijo lateral.....	7
Sistema puerta abatible doble.....	8
Sistema puerta abatible doble + fijos en laterales.....	9
Cortes de piso.....	11

GENERALIDADES DEL SISTEMA TITANIUM

	Mínimo	Máximo
Ancho de la hoja:	Abatible interior: cualquiera Abatible exterior: 450 mm	1100 mm
Alto de la hoja:		4000 mm
Dimensión del perfil de hoja:	54x114 mm	
Dimensión del perfil de marco:	Para malla fija: 47mm x 64.9mm Para abatible: 47mm x 66.4mm	
Peso máximo:	120 kg	
Espesor máximo de vidrio:	36 mm	

CONFIGURACIONES POSIBLES

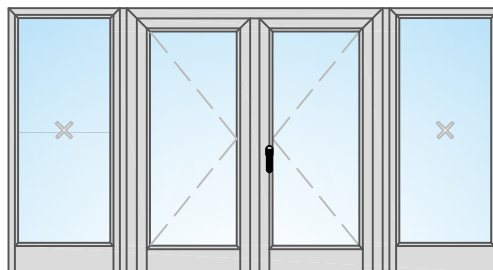
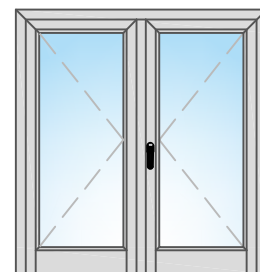
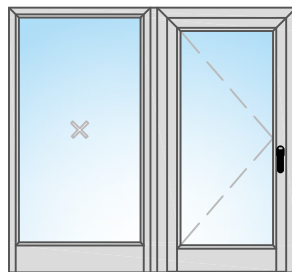
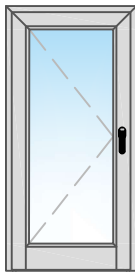

Escala 1:1

Secciones genéricas

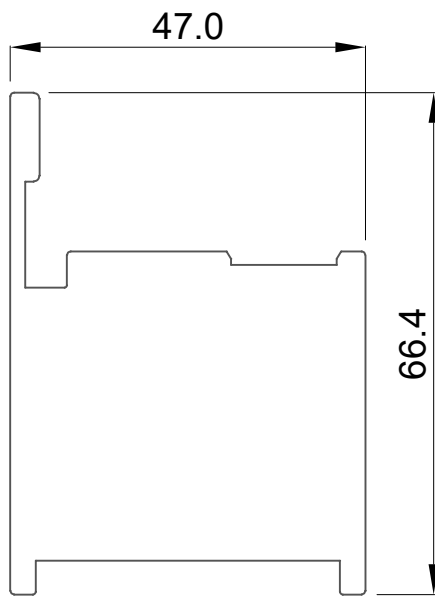

FI-4863
MARCO DE ABATIBLE

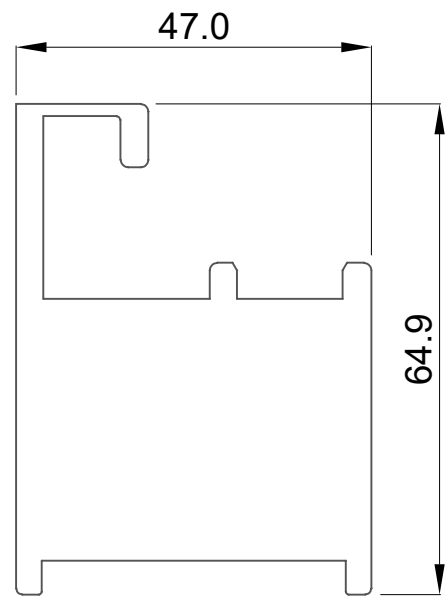

FI-4263
MARCO PARA FIJO

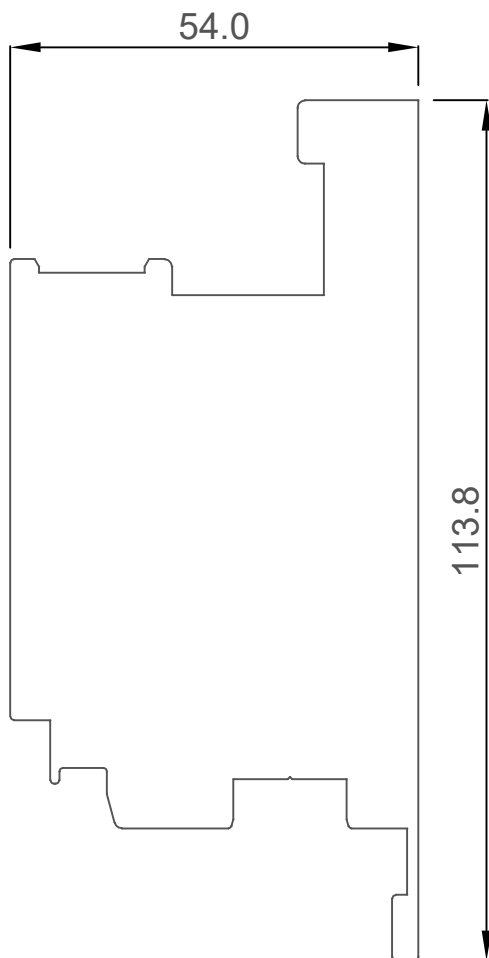

FI-4864
HOJA ABATIBLE
APERTURA EXTERIOR

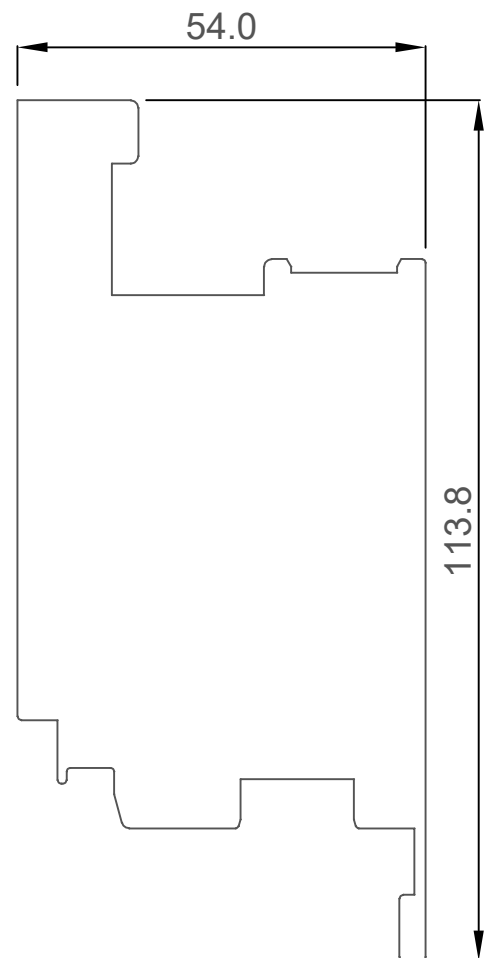

FI-4861
HOJA ABATIBLE
APERTURA INTERIOR

Escala 1:1

Secciones genéricas

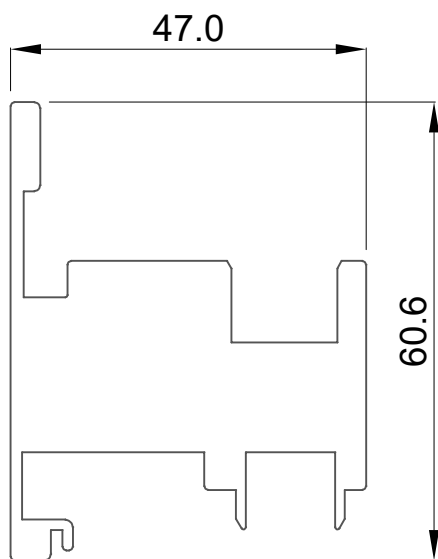

FI-4862
INVERSOR DE HOJA

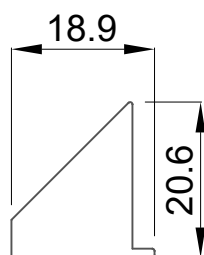

FI-4869
VIERTE AGUA

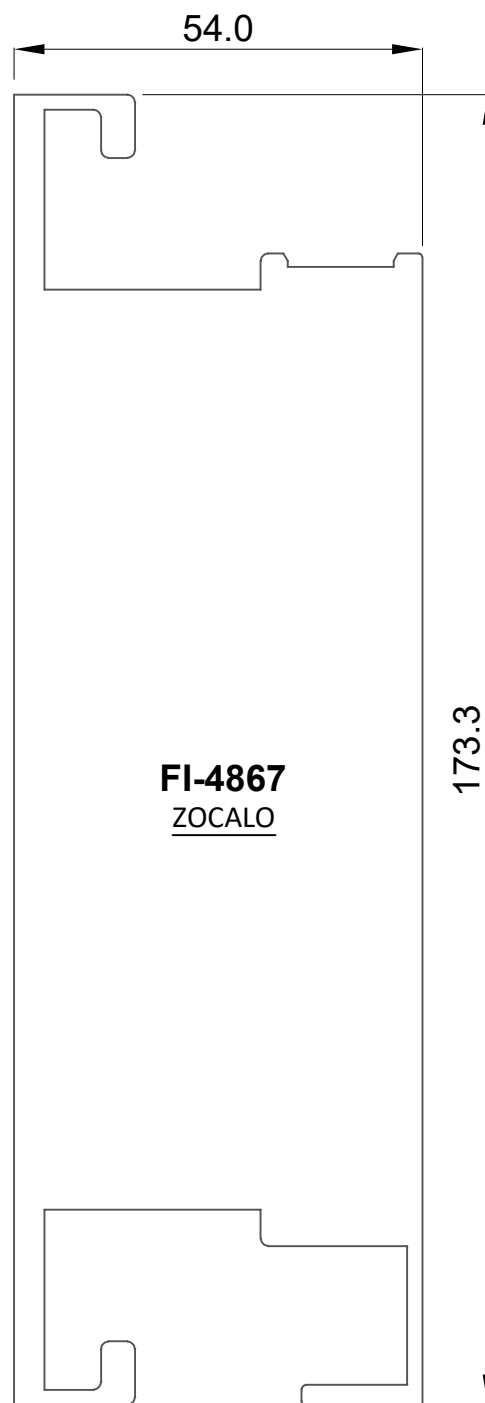

FI-4867
ZOCALO

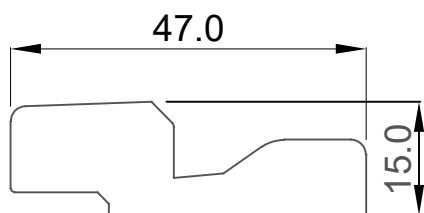

FI-5111
SARDINEL APERTURA
INTERIOR

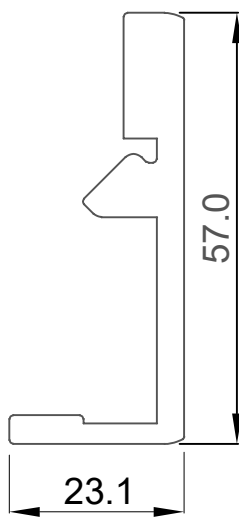

FI-4868
BATIENTE ZOCALO

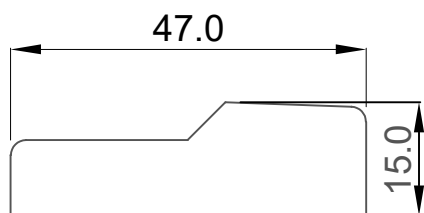

FI-4866
SARDINEL APERTURA
EXTERIOR

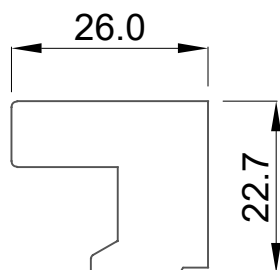

FI-4467
JUNQUILLO RECTO

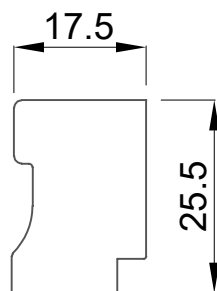

FI-5123
JUNQUILLO CLIPADO

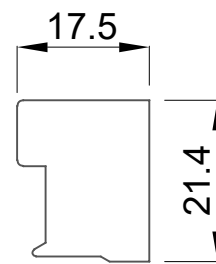

FI-4261
JUNQUILLO RECTO

Escala 1:2

Secciones genéricas

Sección B-B'

Corte Vertical

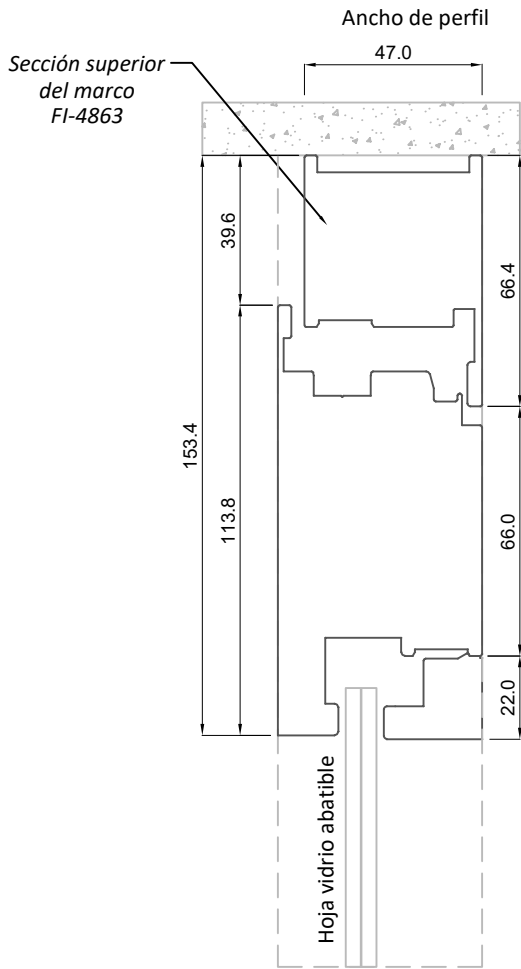

Detalle de espesor de vidrio

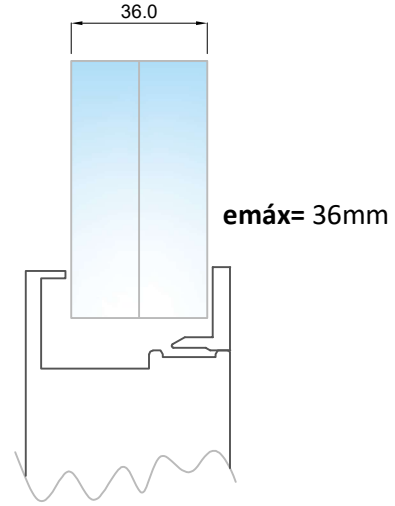

Puerta Genérica Abatible

Opción: Malla Enrollable

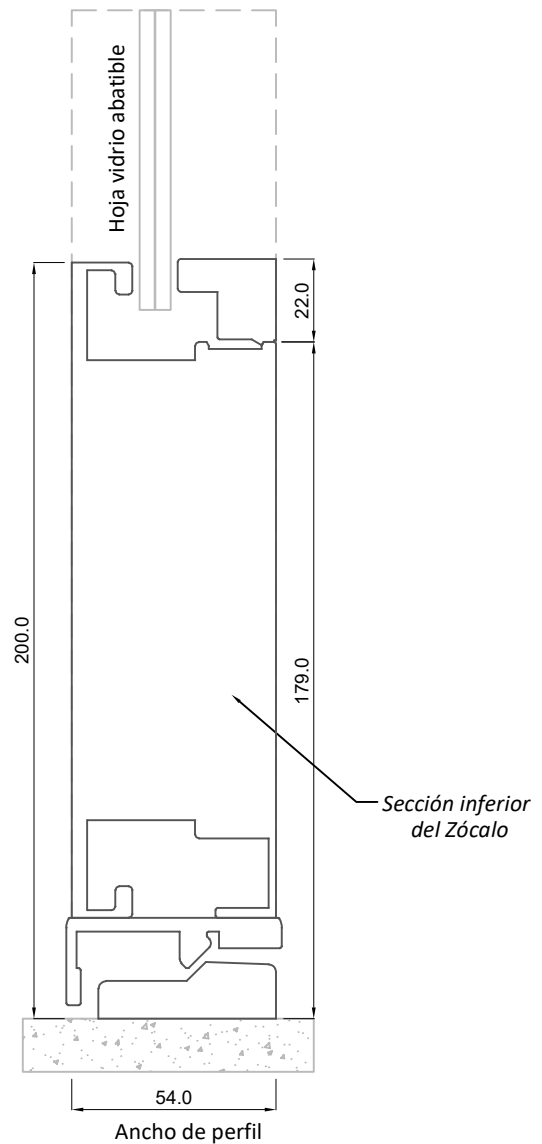
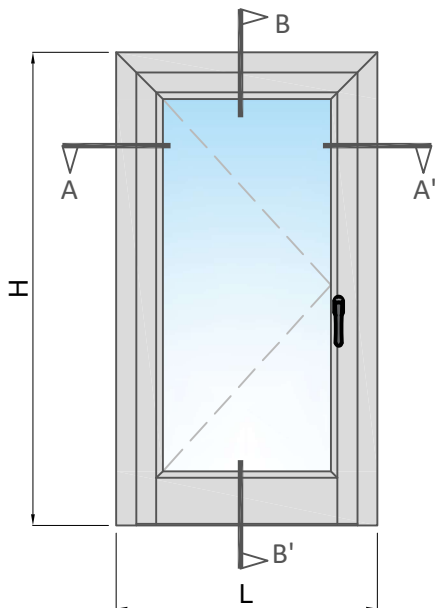

Unidades en milímetros

Secciones genéricas

Escala 1:2

Sección A-A'

Corte Horizontal

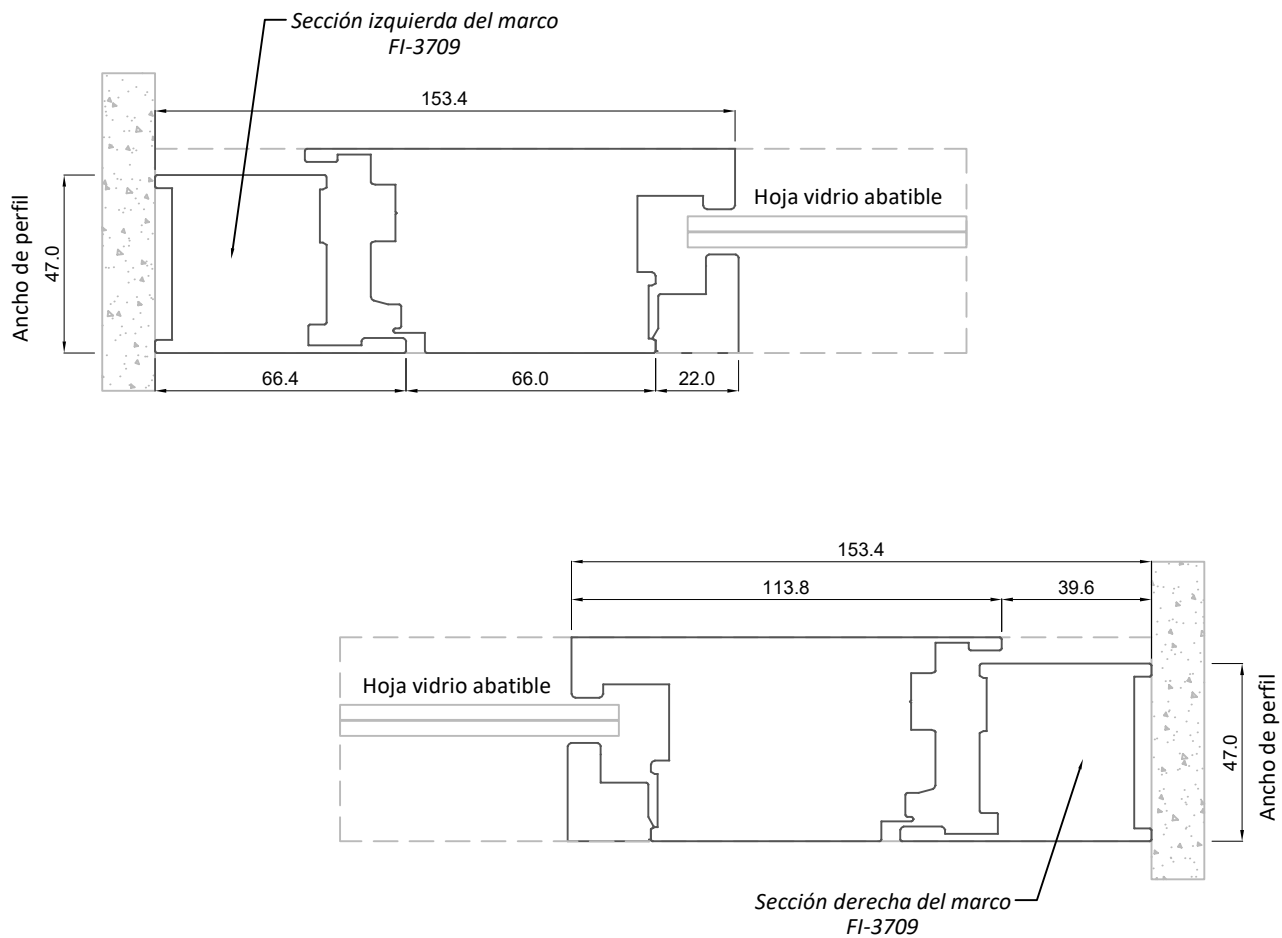

Titanium Puerta Abatible

Escala 1:5

Abatible interior con malla Legacy
Sección A-A'

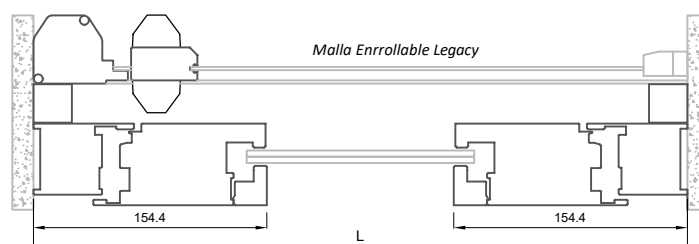
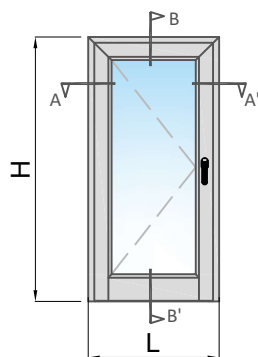

Abatible exterior con malla Legacy
Sección A-A'

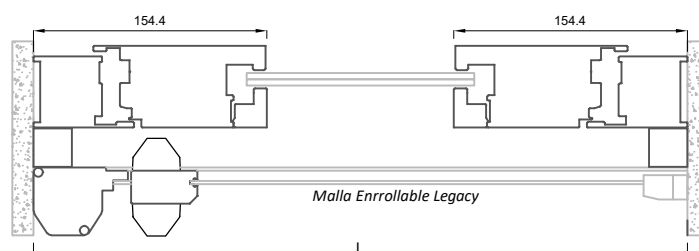

Nota:

- La malla es opcional.

Escala 1:5

Titanium Puerta

Abatible exterior
con malla Legacy
Cuando riel inferior
va empotrado en piso

Sección B-B'

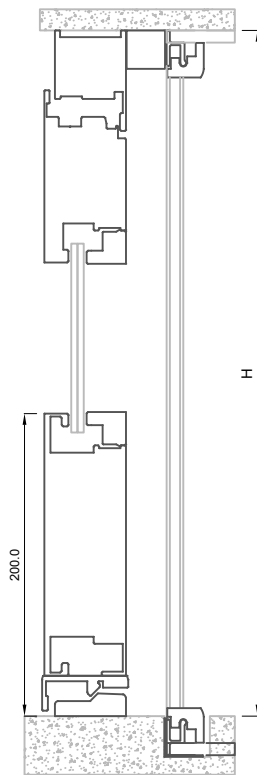

Abatible exterior
con malla Legacy
Cuando riel inferior
va sobre piso

Sección B-B'

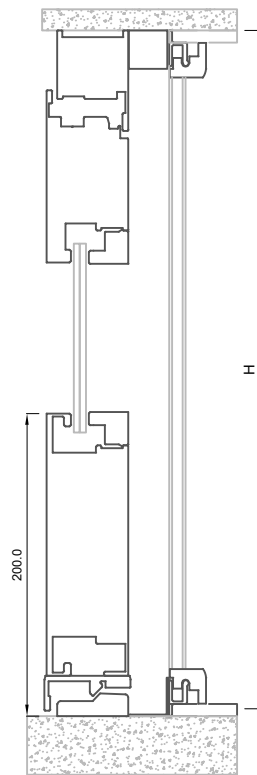

Abatible interior
con malla Legacy
Sección B-B'

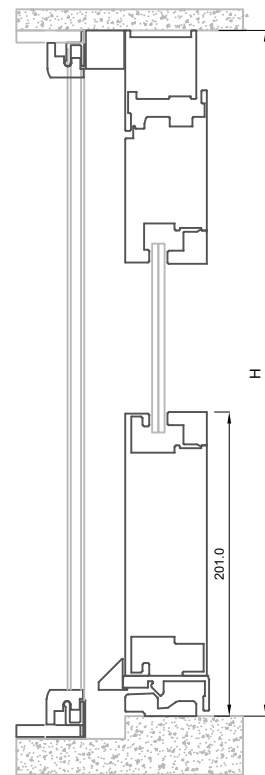

Escala 1:5

Titanium Puerta

Abatible + Fijo en lateral

Nota:

- La malla es opcional.

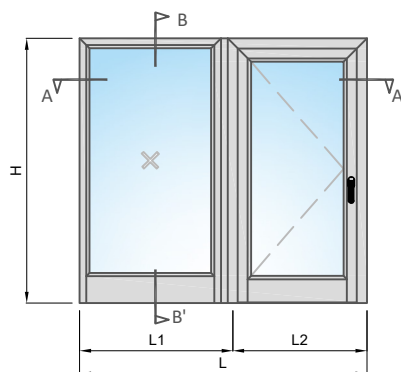

Abatible interior con malla Legacy
Sección A-A'

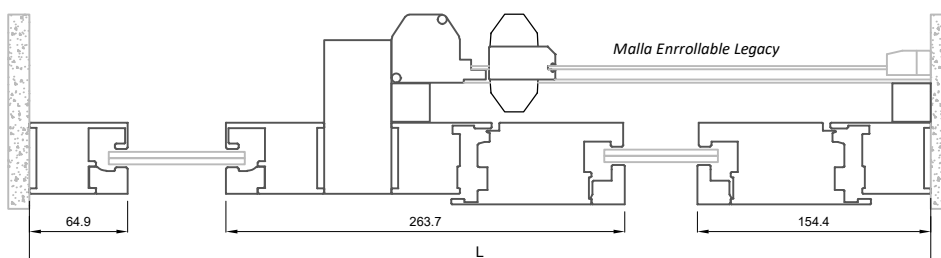

Sección B-B'

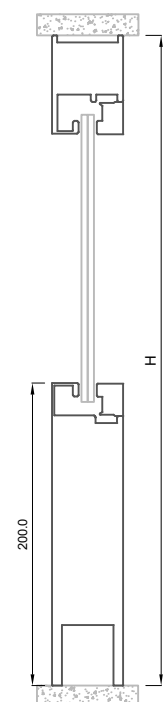

Titanium Puerta

Escala 1:5

Abatible + Fijo en lateral

Abatible exterior con malla Legacy
Sección A-A'

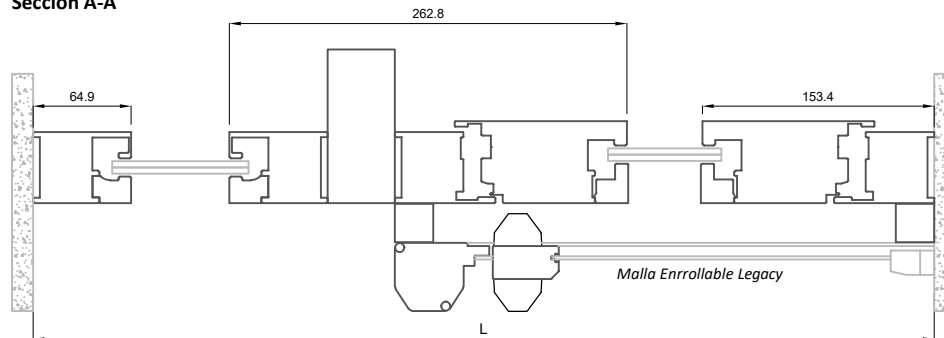

Titanium Puerta

Escala 1:5

Abatible doble

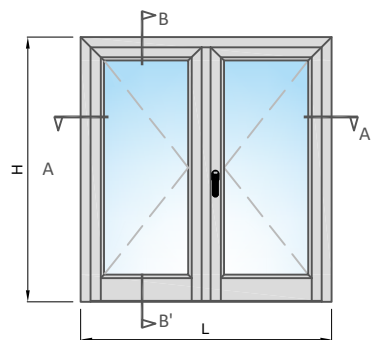

Nota:
- La malla es opcional.

Abatible exterior con malla enrollable Legacy
Sección A-A'

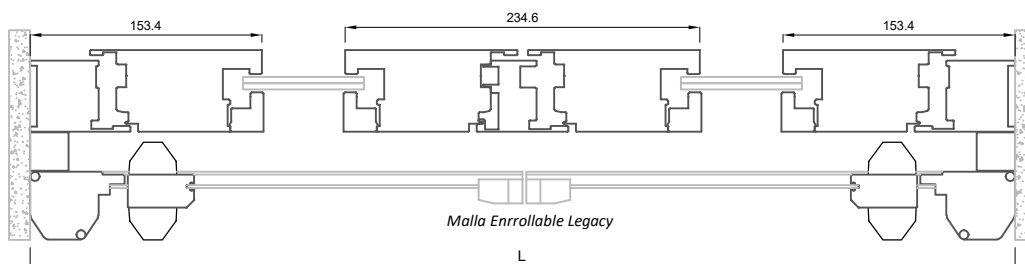

Abatible interior con malla enrollable Legacy
Sección A-A'

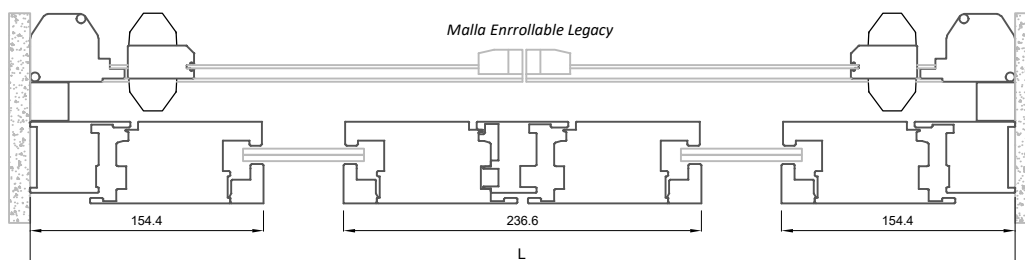

Escala 1:5

Titanium Puerta

Abatible doble

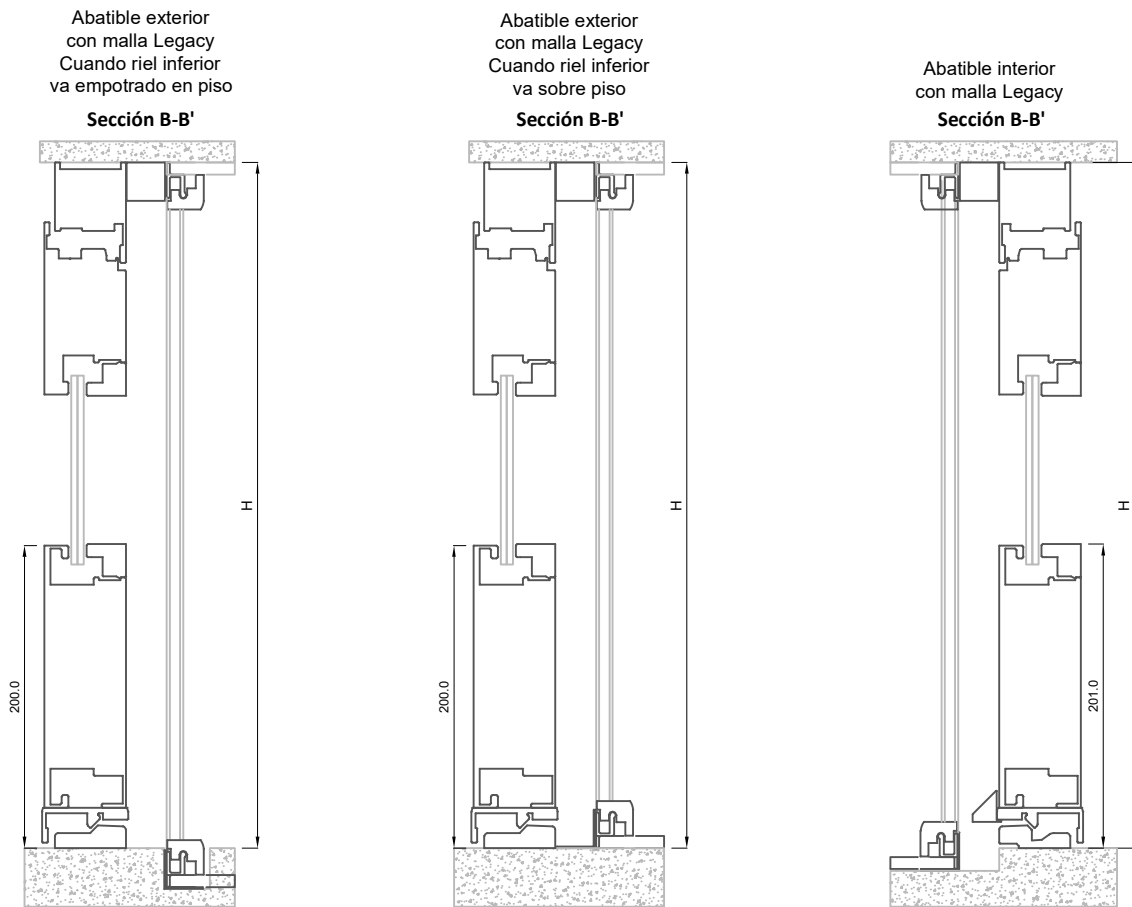

Escala 1:6

Titanium Puerta

Abatible doble + fijos en laterales

Nota:
- La malla es opcional.

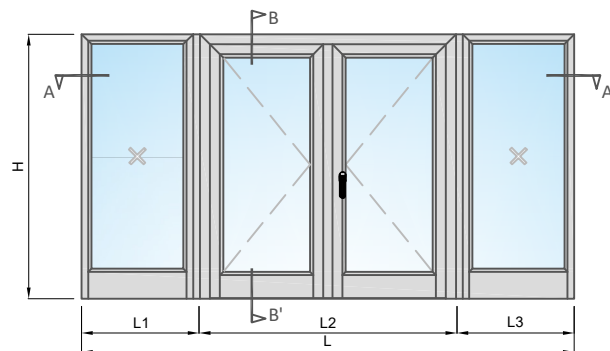

Abatible exterior con malla enrollable Legacy

Sección A-A'

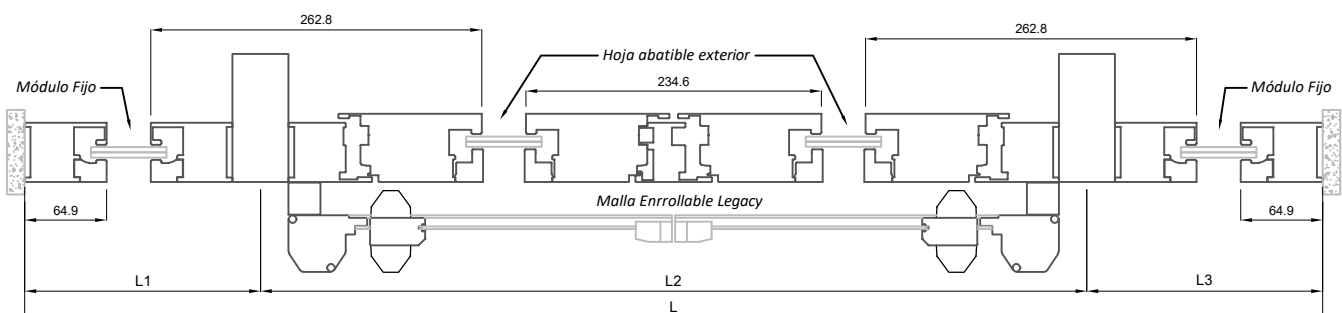

Titanium Puerta

Escala 1:6

Abatible doble + Fijos en laterales

Abatible interior con malla enrollable Legacy

Sección A-A'

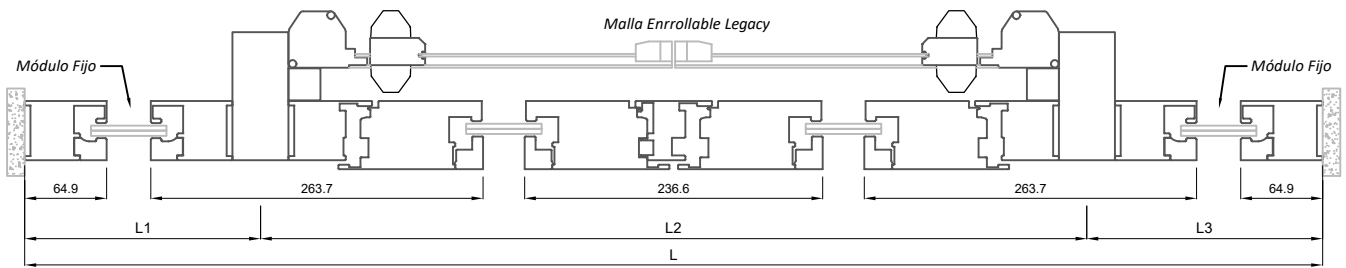

Abatible exterior con malla Legacy
Cuando riel inferior va empotrado en piso
Sección B-B'

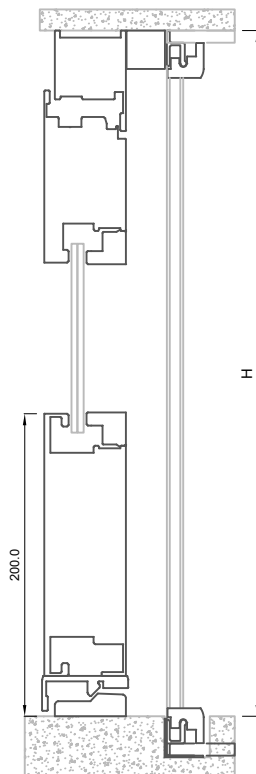

Abatible exterior con malla Legacy
Cuando riel inferior va sobre piso
Sección B-B'

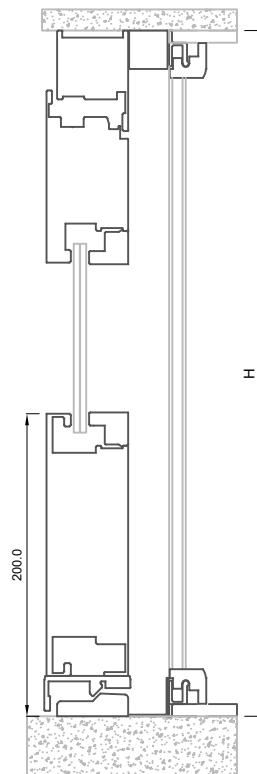

Abatible interior con malla Legacy
Sección B-B'

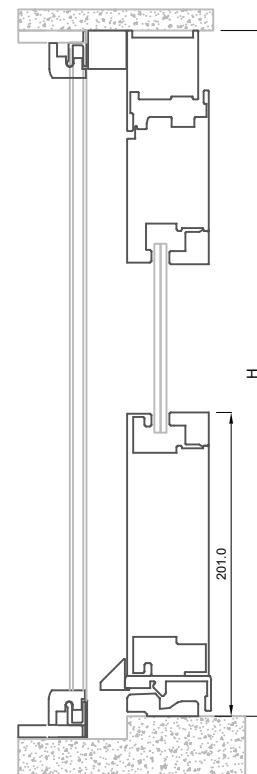

Detalle de corte de pisos - Sistema Titanium

Puertas Titanium

Cortes de piso

Secciones genéricas

Escala 1:4

		Titanium Apertura Exterior				Titanium Apertura Interior	
		Sin malla	Con malla Legacy Riel inferior sobre piso	Con malla Legacy Riel inferior empotrado	Sin malla	Con malla Legacy	
Opción #1							
Opción #2							

Escala 1:4

Titanium Puerta

Secciones genéricas

**Titanium Apertura Exterior - Malla Legacy
Riel inferior empotrado**

Corte Horizontal

